









HUS 6 / HUS-S 6 Screw anchor

Everyday standard screw anchor

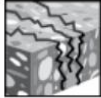
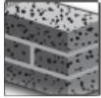

Anchor version	Benefits
----------------	----------

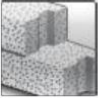
	HUS 6 (6)	<ul style="list-style-type: none"> - Quick and easy setting - Low expansion forces in base materials
	HUS-S 6 (6)	<ul style="list-style-type: none"> - Through fastening - Removable

Base material	Load conditions
---------------	-----------------

					
Concrete (non-cracked)	Concrete (cracked)	Solid brick	Hollow brick	Autoclaved aerated concrete	Fire resistance

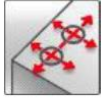
Installation conditions

	
Small edge distance and spacing	Redundant fastening

Approvals / certificates

Description	Authority / Laboratory	No. / date of issue
Assessment report (fire)	warringtonfire	WF327804/A 2013-07-10



Basic loading data (for a single anchor)

All data in this section applies to:

- Correct setting (See setting instruction)
- No edge distance and spacing influence
- Concrete as specified in the table
- Steel failure
- Minimum base material thickness
- Concrete C 20/25, $f_{ck,cube} = 25 \text{ N/mm}^2$
- Applied loads to individual bricks/blocks without compression may not exceed 1,0 kN
- Applied loads to individual bricks/blocks with compression may not exceed 1,4 kN
- Data applies only to bricks/blocks, there is no test data available for loads in mortar joints. Hilti recommends at least 50% load reduction or on site testing, if the location of the anchor in relation to the joint can not be specified because of wall plaster or insulation.
- Plaster, gravelling, lining or levelling courses are regarded as non-bearing and may not be taken into account for calculation of embedment depth

Note:

When tightening the screw anchor in soft base materials and in hollow brick, care must be taken not to apply too much torque. If the screw anchor is over-tightened the fastening point is unusable for the HUS 6.

Base material		Solid masonry units		Autoclaved aerated concrete	
		Mz 12 Solid brick	KS 12 Solid lime block	PB6 Block	PB2 Block
Compressive strength	[N/mm ²]	12	12	6	2
Bulk density	[N/mm ²]	1,8	2,0	0,6	0,2
Format (length/width/height)	[mm]	240/175/113	240/175/113	-	-

Recommended loads^{a)}

Anchor size		6														
Anchor type		HUS 6														
Base material		Non-cracked concrete		Cracked concrete ^{a)}		Solid brick ^{b)} MZ 20		Lime block ^{b)} KS sand		Hollow Brick ^{b)} Hiz 0.8/12		PB / PB4 ^{c/d)}		PB6 ^{c)}		
Nominal embed. depth	h_{nom} [mm]	34		44		44		44		64		64		64		
Edge distance	$c \geq$ [mm]	60	30	100	60	30	60	30	60	30	60	30	60	30	60	30
Tension N_{Rec}	[kN]	1,0	1,0	0,5	0,2	0,2	1,0	1,0	0,1	0,1	0,2	0,2	0,2	0,2	0,2	0,2
Shear V_{Rec}	[kN]	1,6	0,5	0,5	0,4	0,3	1,1	0,4	0,4	0,2	0,3	0,1	0,6	0,2		

- a) Redundant fastening
- b) Holes must be drilled using rotary action only (no hammering action)
- c) Aerated concrete
- d) No anchor hole drilling required in PB2/PB4 gas aerated concrete
- e) With overall partial safety factor for action $\gamma = 1,4$. The partial safety factors for action depend on the type of loading and shall be taken from national regulations.



Materials

Mechanical properties

Anchor size	HUS 6 / HUS-S 6	
Nominal tensile strength f_{uk} [N/mm ²]	1000	
Yield strength f_{yk} [N/mm ²]	900	
Stressed cross-section A_s [mm ²]	5,2	
Moment of resistance W [mm ³]	13,8	
Design bending resistance $M^{0}_{Rk,s}$ [Nm]	11	

Material quality

Part	Material
Screw anchor	Carbon Steel,galvanized $\geq 5 \mu\text{m}$

Anchor dimensions

Anchor size	HUS 6	HUS-S 6
Nominal length of screw l_s [mm]	35 - 220	100 - 220
Core diameter d_k [mm]	5,3	5,3
Shaft diameter d [mm]	7,5	7,5

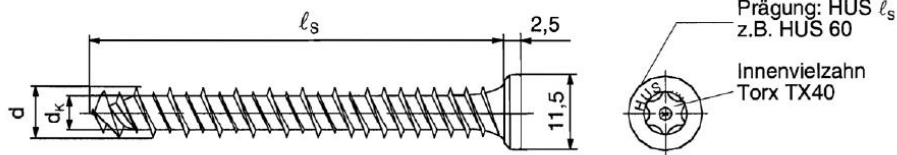

Head configuration HUS-S

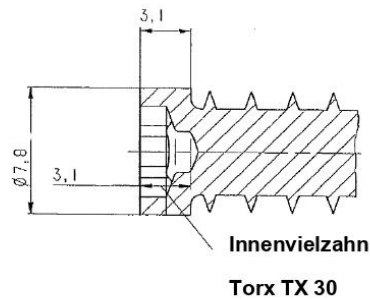



Setting information

Setting details

Anchor size		6				
Anchor type		HUS				
Base material		Concrete C20/25	Solid brick /Mz 20	Hollow Brick Hz 0.8/12	PB / PB4 ^{c)}	PB6 ^{c)}
Nominal embed. depth	h_{nom} [mm]	34	44	64	64	64
Nominal diameter of drill bit	d_0 [mm]	6	6	6	-	6
Cutting diameter of drill bit	d_{cut} [mm]	6,4	6,4	6,4	-	6,4
Minimum depth of drill hole	$h_1 \geq$ [mm]	50	54 ^{b)}	64 ^{a)}	- ^{b)}	70
Diameter of clearance hole in the fixture to clamp a fixture	$d_r \leq$ [mm]	8,5				
Diameter of clearance hole in the fixture for stand-off	$d_r \leq$ [mm]	6,2				
Max. fastening thickness	t_{fix} [mm]	$l_s - h_{nom}$				
Max. installation torque	T_{inst} [mm]	10	4	2	2	2

- a) Holes must be drilled using rotary action only (no hammering action)
- b) No anchor hole drilling required in PB2/PB4 gas aerated concrete
- c) Aerated concrete

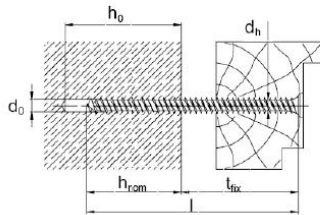

HUS

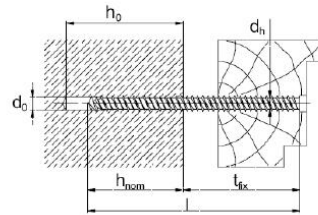

HUS-S

Installation equipment

Anchor size	HUS 6	HUS-S 6
Rotary hammer	TE 6 / TE 7	
Drill bit	TE-C3X 6/17	
Recommended setting tool	SID / SIW 121, SID / SIW 144, TKI 2500	
Accessories	S-B TXI 40 bit	S-B TXI 30 bit



Permissible anchor location in brick and block walls:

- Distance to free edge free edge to solid masonry (HLz and autoclaved aerated gas concrete) units ≥ 170 mm
- Distance to free edge free edge to solid masonry (Mz and KS) units ≥ 200 mm
- The minimum distance to horizontal and vertical mortar joint (c_{min}) is stated in the recommended load table.
- Data applies only to bricks/blocks, there is no test data available for loads in mortar joints. Hilti recommends at least a 50% load reduction or on site testing, if the location of the anchor in relation to the joint (see drawing) can not be specified because of wall plaster or insulation.
- Minimum anchor spacing (s_{min}) in one brick/block is $\geq 2 \cdot c_{min}$

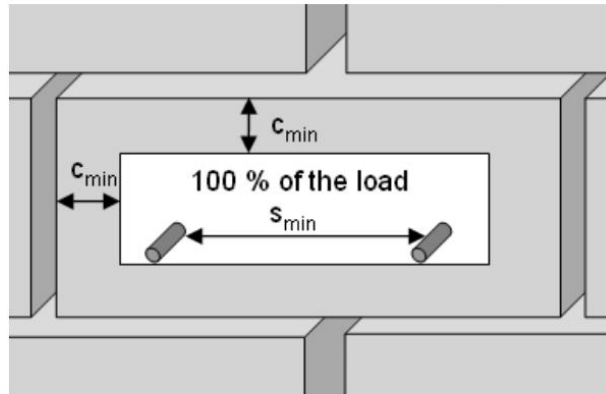

Setting instructions

*For detailed information on installation see instruction for use given with the package of the product

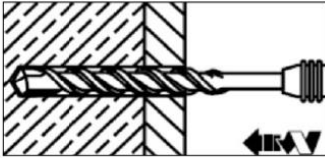
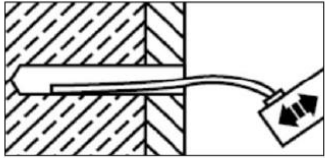
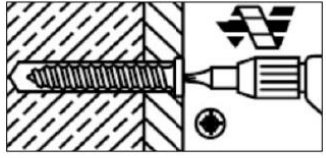
Setting instruction for HUS		
1. Drill hole with drill bit	2. Clean the hole	3. Install the anchor with an electric screw driver
		
Setting instruction for HUS-S		
1. Drill hole with drill bit	2. Clean the hole	3. Install the anchor with an electric screwdriver.
